



- 2, 3 or 4 Axis
- Colorful LCD
- User Designated Resolution
- USB or RS232 Port Option
- Open Collector Outputs
- 2D Simulations
- Angle Measurement
- 85 – 265 VAC Supply
- 1000 Coordinate Memory
- 7 Language Options

کانون ابزار

تلفن :

021 66 39 39 00

0912 147 3023

ali5.ir

New LCD DRO, ADR-50 Series Digital Readouts can meet the application in all machine tools with maximum performance and it includes features that are essential for increasing productivity. 7 different language choice is existed as Turkish, English, German, Spanish, Portuguese, Italian and Dutch. USB or RS232 port connection available. Functions can be used with 2D simulations.

ADR 50 has 6 Open Collector outputs. Every output can be used with a chosen axis.

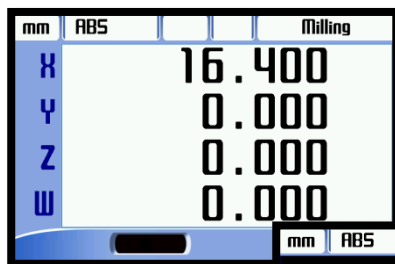

- ✓ Rectangular Pocket
- ✓ Bolt Hole
- ✓ Linear Pattern

- ✓ Radius
- ✓ Taper Measure
- ✓ Angle Measure

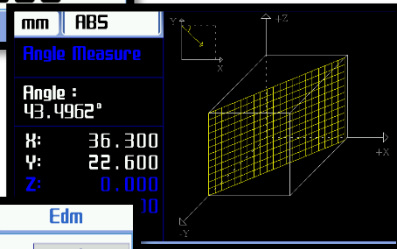

- ✓ Error Compensation
- ✓ Axis Summary
- ✓ Diameter Mode

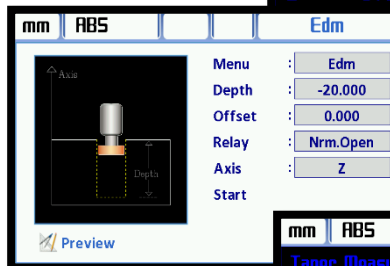

- ✓ Erosion
- ✓ User Modes
- ✓ Shrink

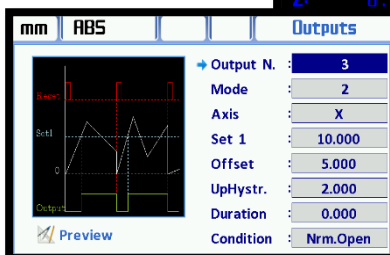
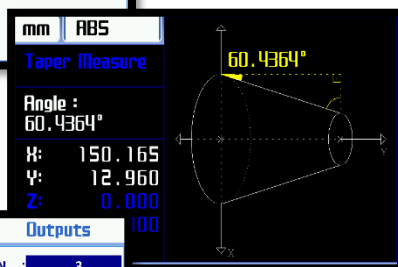

And more functions...

Technical Specifications

Number Of Axis	2, 3, 4
Display	Color LCD
Display Resolution	User can designate as requested
Input Signal	Available Push Pull or TTL A,B,Z (Line Driver A, B, Z, /A, /B, /Z) Incremental Encoder Signals
Weight	~ 2,7 Kg
Power Supply	85 – 265 VAC 50/60 Hz.
Storage Temperature	- 25 ~ 65 °C
Operation Temperature	-10 ~ 45 °C
Relative Humidity	%20 - %85
Protection Class	IP54
Dimensions (H x W x T)	202mm x 320mm x 84mm
Housing	Aluminum Injection Housing

Order Code

Model

A D R 5 0 - X

Axis Number

- 2 : 2 Axis
- 3 : 3 Axis
- 4 : 4 Axis



Mechanical Dimensions

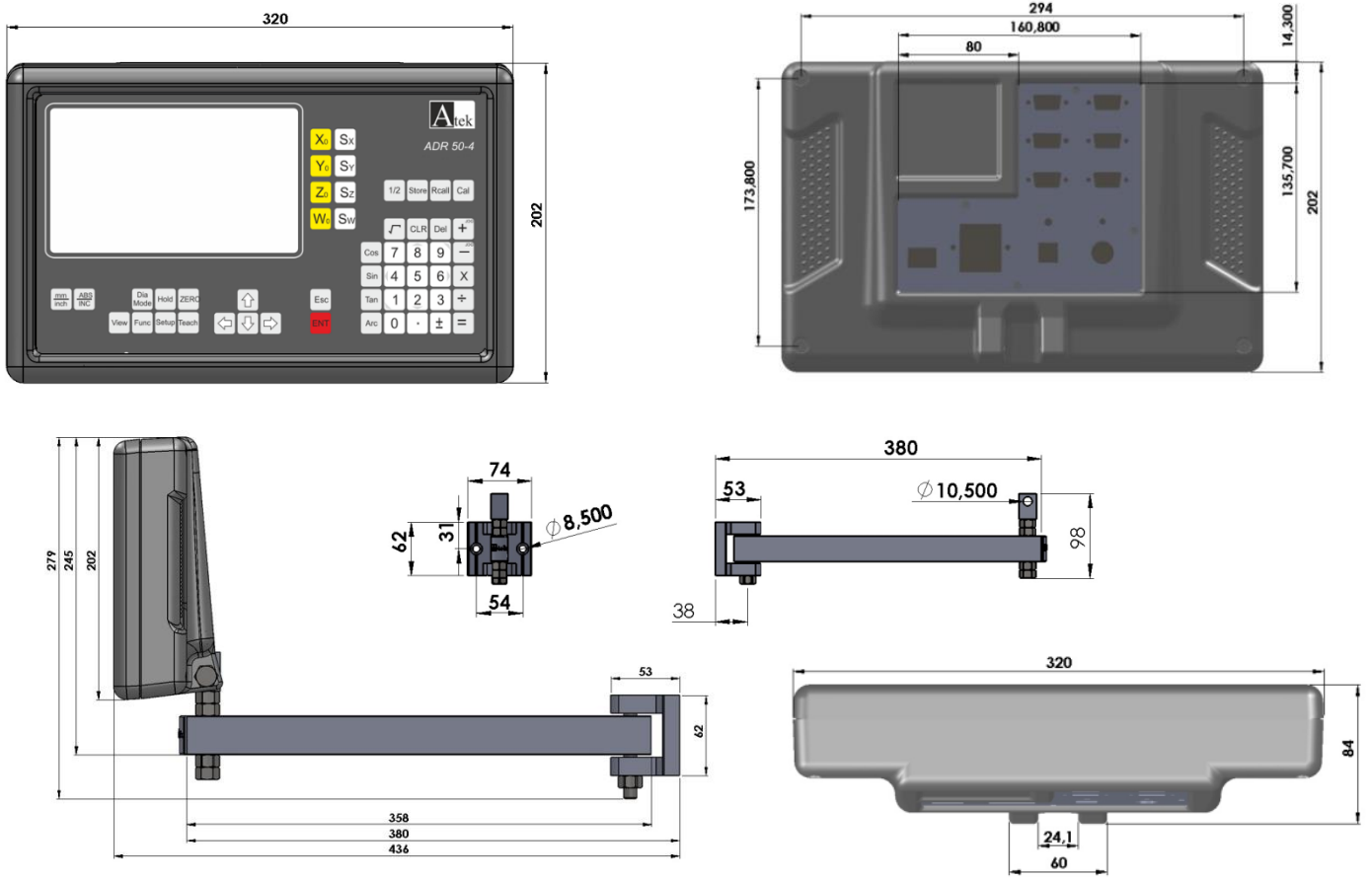

Connections

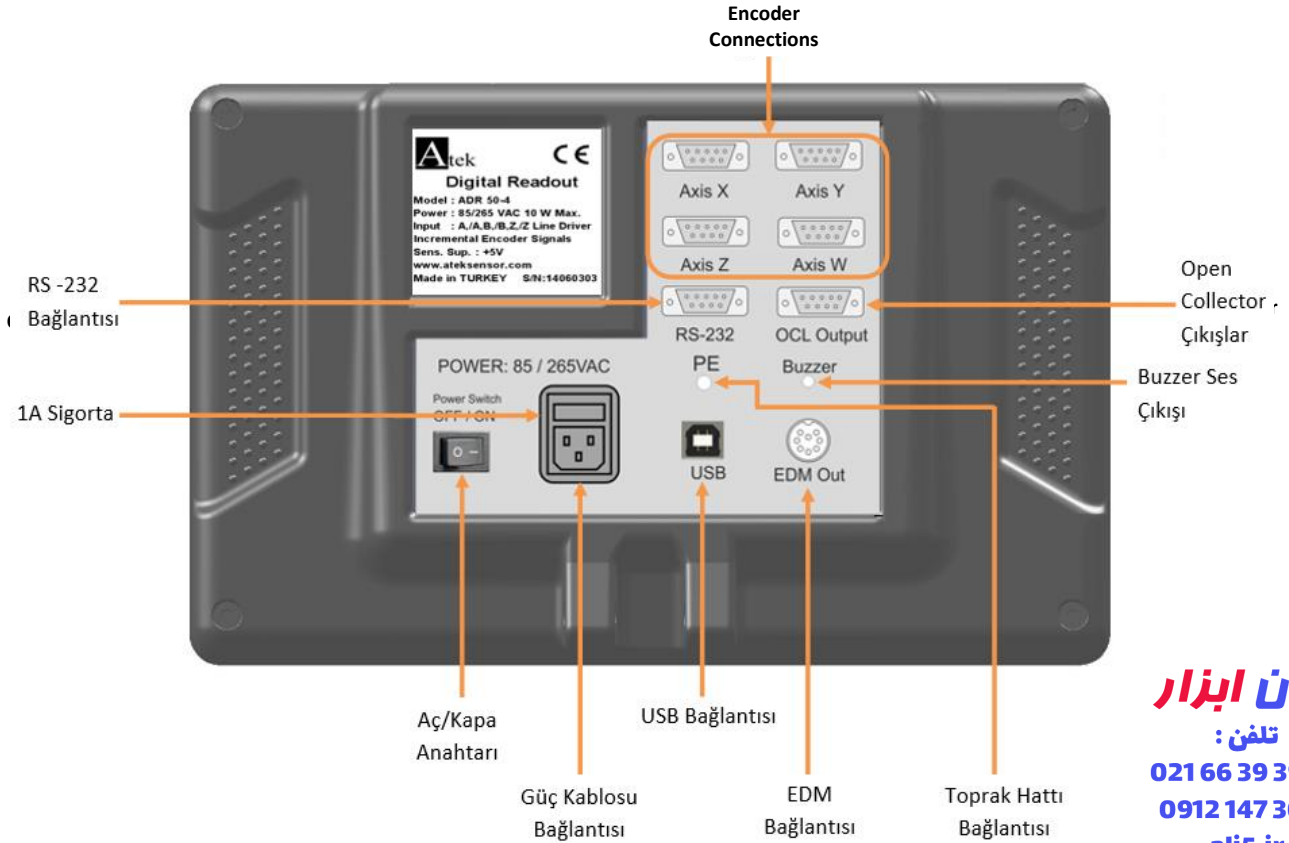

کانون ابزار

تلفن :

021 66 39 39 00

0912 147 3023

ali5.ir

Atek Elektronik Sensör Teknolojileri Sanayi ve Ticaret A.Ş.

Gebze OSB, 800. Sokak, No:814 Gebze/KOCAELİ/TURKEY

Tel: +90 262 673 76 00

Fax: +90 262 673 76 08

www.ateksensor.com

info@ateksensor.com

